

かぞく まもる

図面集

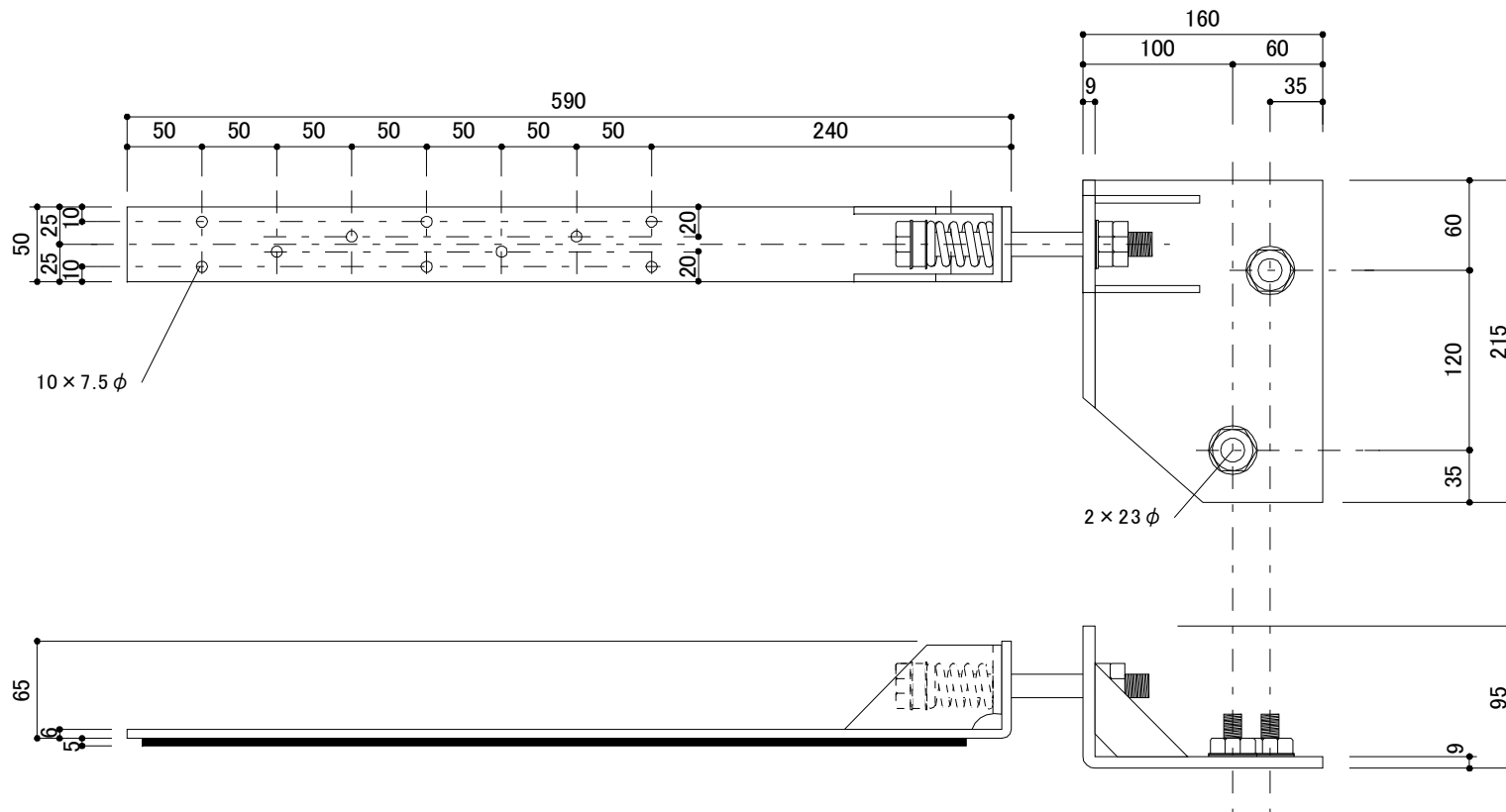

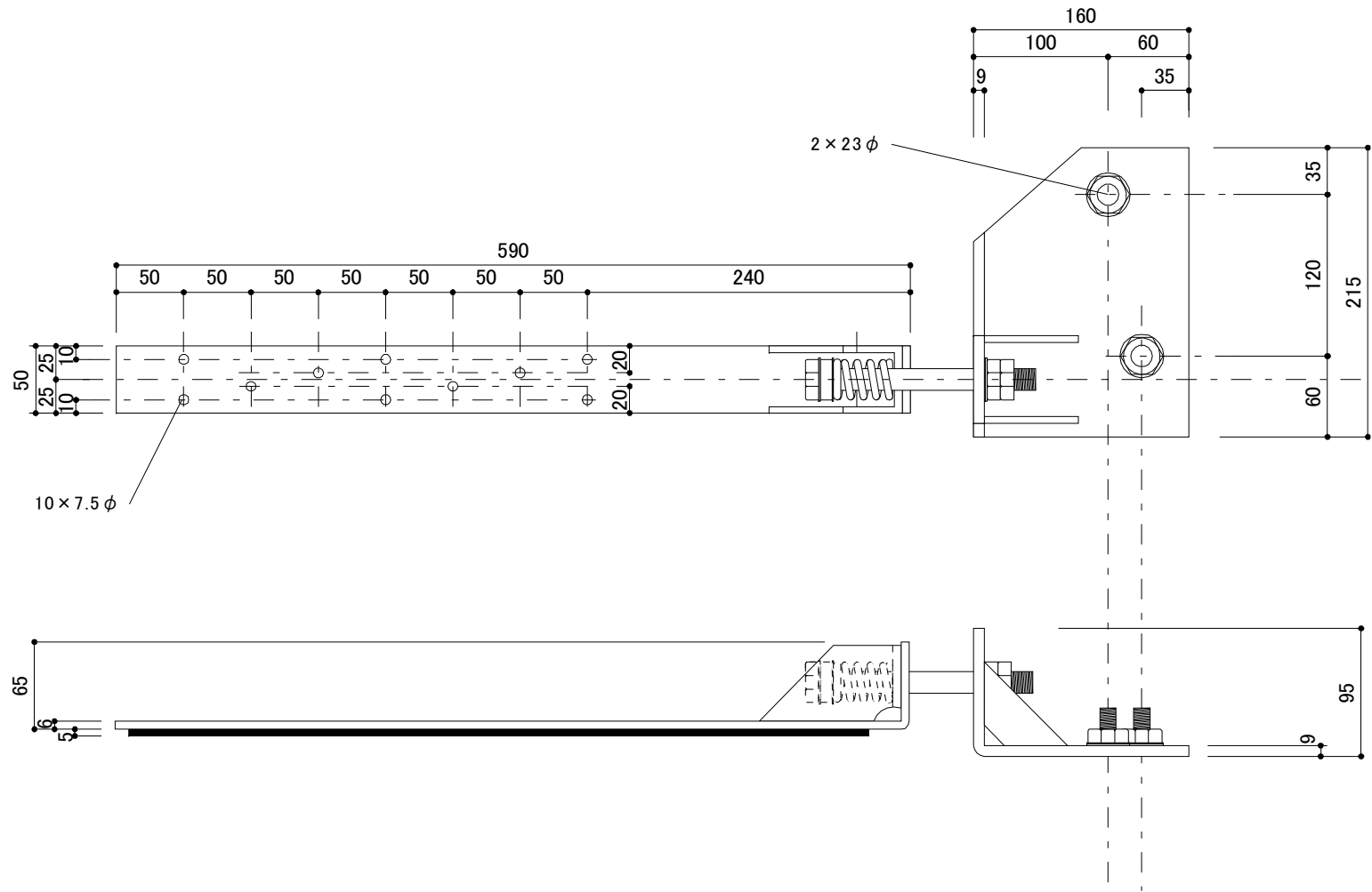

Aim Corporation

エイム 株式会社

埼玉県川口市弥平2-20-3 エイムWingビル
 TEL:048-224-8160 FAX:048-224-8180

プロテクター(右)

詳細図

Scale 1/5

140702

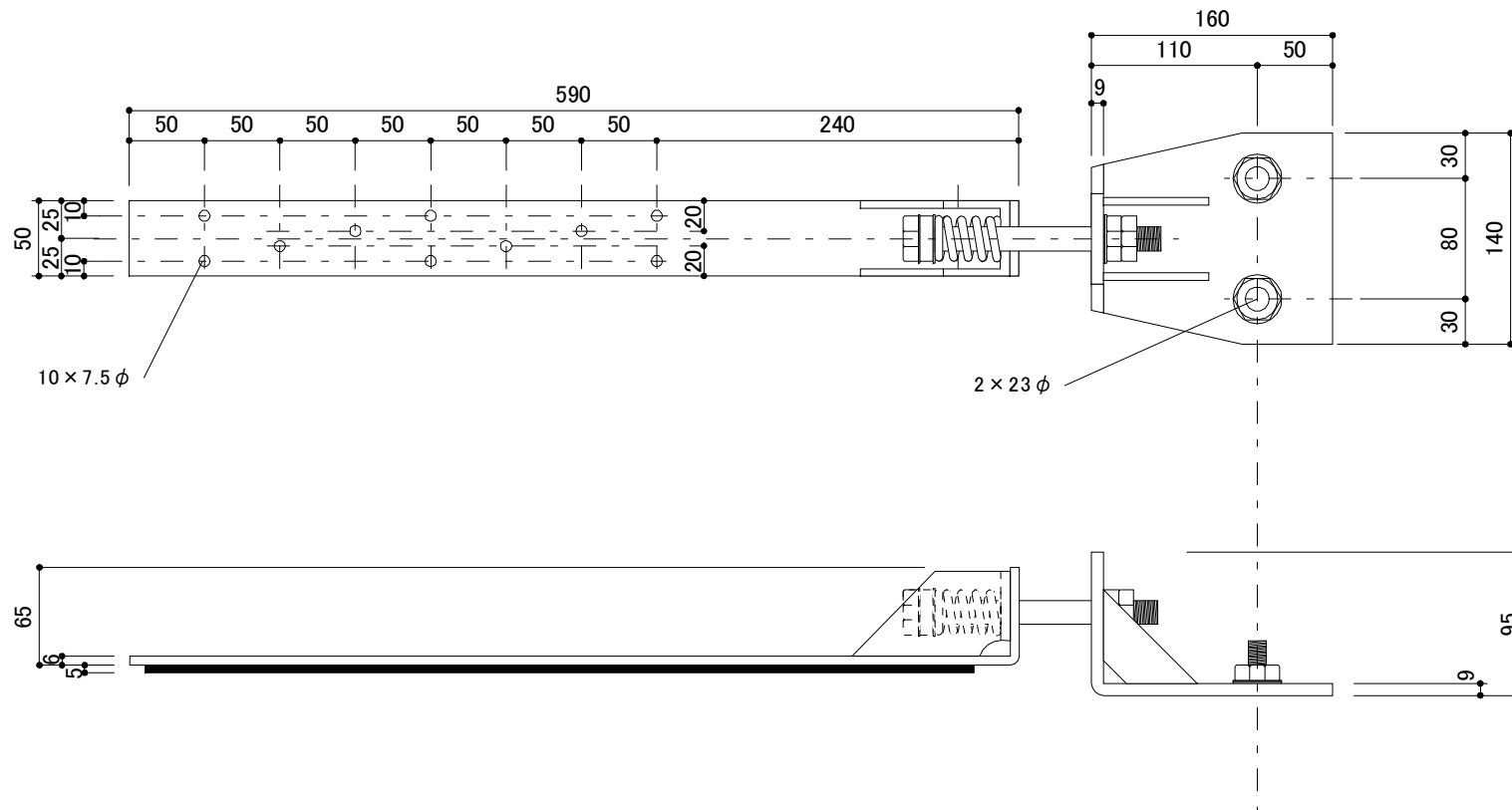

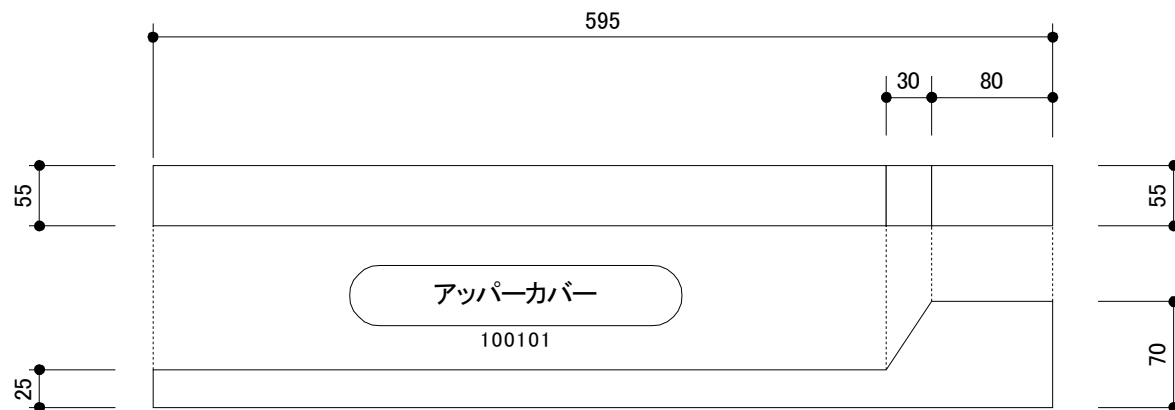

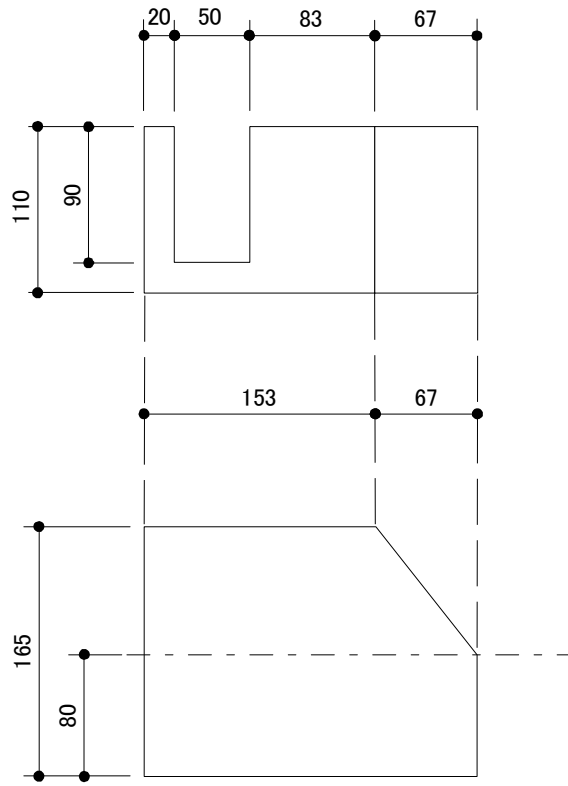

片面ローカバー(右)

100109

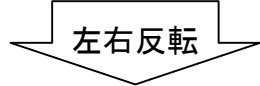

片面ローカバー(左)

100108

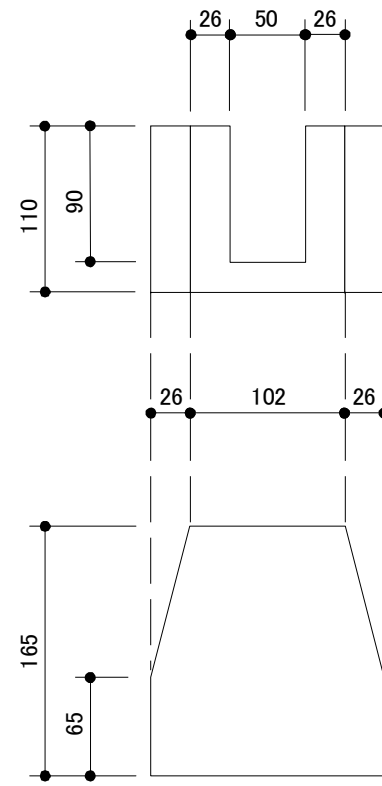

平面ローカバー

100110

平面

100303

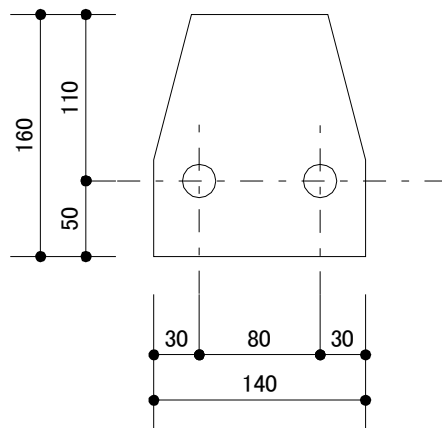

片面(左右共通)

100300

